

## Pre Installation

### Check dimensions

- Make sure that the opening is the correct size for the doorset. The dimensions of the opening should be at least 5mm greater than the outer dimensions of the doorset on all four sides.
- Take several measurements of the width and height to ensure that the dimensions are constant. Do not force the doorset into position as this may distort or damage the product.

### Installing

- The doorset must be installed as a complete unit. Use the door leaf as a template to square up the door frame position, removing it only to allow for final fixing, decoration or protection.

### Important notes

- Regardless of the fixing method used screws, bolts, or straps, packing must be inserted between the frame and the wall at the fixing point. This will avoid frame distortion.
- It is also important to ensure that a packing piece is placed immediately behind the lock striking plates where they are positioned in the frame.
- Frame fixings into the wall must be made immediately above and below the strike plate.
- After fixing is complete, ensure that the door makes full and consistent contact with the seals.
- Check the diagonals and ensure that no twisting or distortion has occurred during installation.
- Where fixing bolts are used, the holes should be drilled through the frame at the distances shown in the diagram overleaf.
- Take care not to over tighten fixings as this may cause splitting, cracking and distortion.
- After final fitting gaps between door frame and wall must be filled with an intumscent infill, tested in accordance with BS 476 Part 20:22 and finished off with a capping sealant.

### Finishing of installation

- Make sure that the door leaf opens and closes properly and the locking system operates smoothly. Also check that the seal is making full contact with the door at all points.

### Cleaning

- Should any surface require cleaning after installation is complete, use a damp cloth or mild soapy water. Do not use any industrial or abrasive cleaner.

# ANOSSECURE DOORSETS FD30

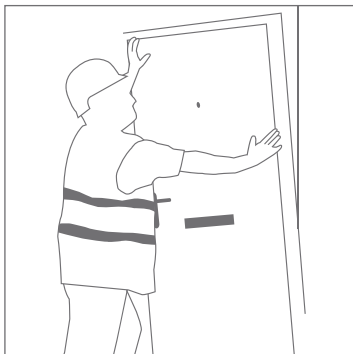

**1.** Offer the doorset unit up to the pre-formed opening.

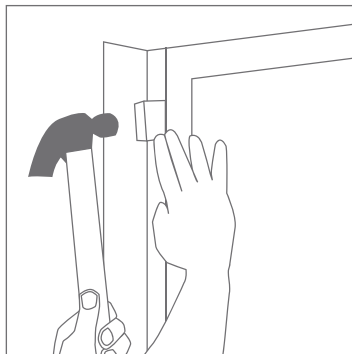

**2.** Use wedges to hold the doorset in place. Ensure that all jambs are square and plumb using a large spirit level.

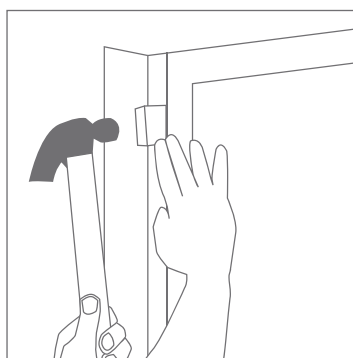

**3.** After ensuring the hinge jamb is square and plumb by re-adjusting the wedges, fix the hinge jamb in the four positions as shown in the diagram.

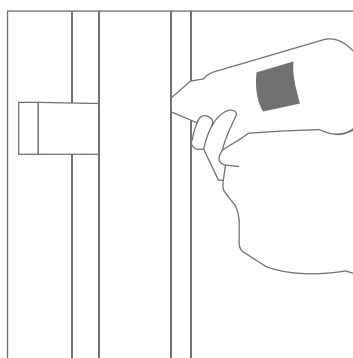
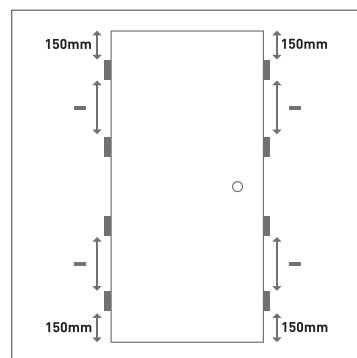

**4.** Close the door and position the closing jamb so that it makes full contact with the seal along the entire length of the jamb, then fix as shown in step 3.

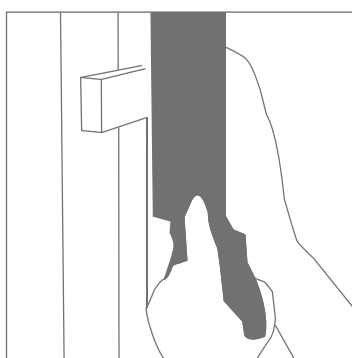

**5.** Cut off the wedges flush with the edge of the door frame and ensure the door opens and closes and the locking mechanism operates smoothly and correctly.

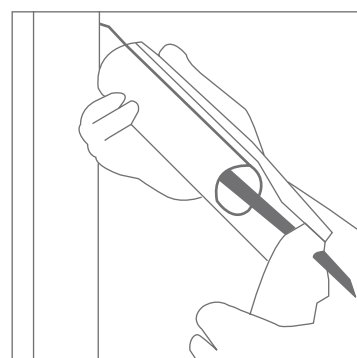

**6.** Fill the gaps between the frame and wall with an intumescent infill, tested in accordance with BS 476 Part 20:22 and finished off with a capping sealant.